



# str/nds

## S 35 M

	Ø 35 mm		<b>50Hz</b>	<b>60Hz</b>
			75-160 265-440 535-890 1490-3010	90-190 320-640 530-1060 1790-3610
	150 mm		1,40/2,00 kW	1,60/2,20 kW
	M20 / M24		<b>mm/r</b>	<b>inch/r</b>
			0,10 0,15 0,22 0,30	0,004 0,006 0,009 0,012
	MK 4			
	500 x 400 mm			



300

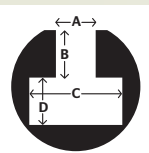

A 14,5 +/- 0,8 mm  
B 13 mm  
C 26 mm  
D 12 mm

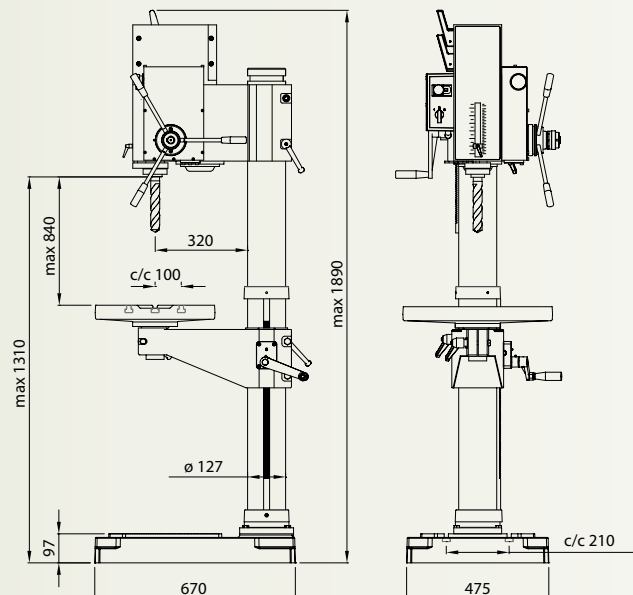

**MSC**   
Machinery  
Scandinavia

# Tillbehör S 35 M

Spare parts/Zubehör

strands



T25095



T35000

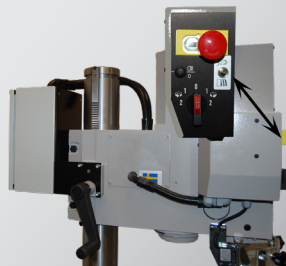

T35001



T25003



T30006



T35009

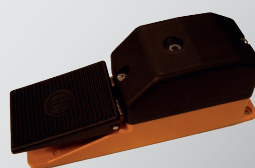

T35010



T35013



T35014



T25021

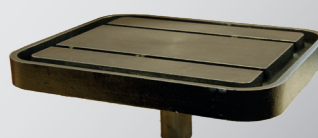

T35023

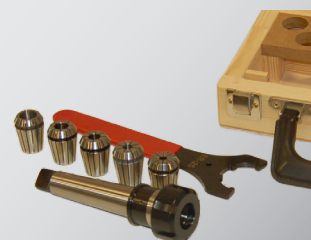

T40042



T40040 0-13 mm



T40041 3-16 mm

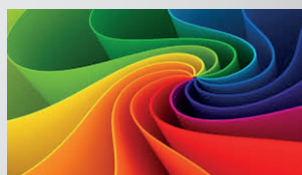

TFARGO

Std EU

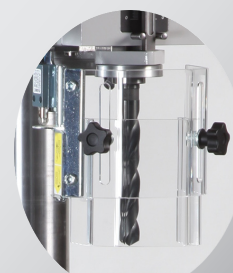

T25014 + T25052

**MSC**   
**Machinery  
Scandinavia**

Machinery Scandinavia AB  
570 83 Rosenfors, Sweden  
Tel +46 495 49 700  
Fax + 46 495 207 30  
E-mail: sales@mscab.se  
[www.strandsmachinery.com](http://www.strandsmachinery.com)