











str/nds

S 25 B

			50Hz	60Hz
				Ø 25 / 28 mm
	130 mm		0,65/0,90 kW	0,80/1,10 kW
	M16 / M20			
	MK 3			
	500 x 400 mm			



120

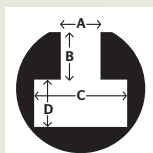

A 14,5 +/- 0,8 mm
 B 13 mm
 C 26 mm
 D 12 mm

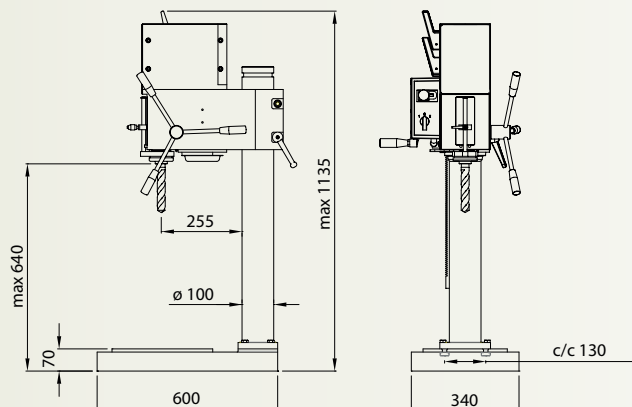

MSC 
**Machinery
 Scandinavia**

Rätt till ändringar av tekniska data utan föregående meddelande förbehålles.
 We reserve the right to make modifications without prior warning.
 Das recht auf Änderung der vorstehenden Daten behalten wir uns vor.

Tillbehör S 25 B

Spare parts/Zubehör

strands



T25095



T25000

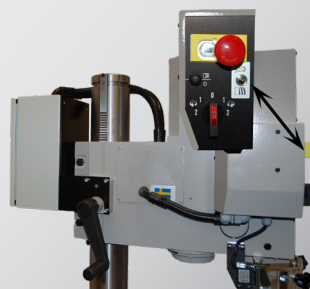

T25001



T25B03



T25006



T25009

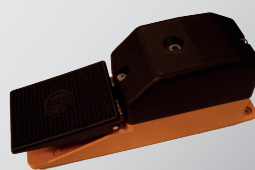

T25010



T25012



T25013



T25021

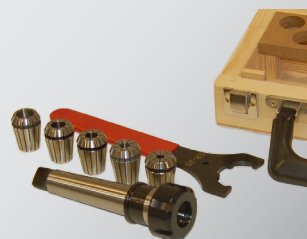

T25U42



T30040 0-13 mm



T30041 3-16 mm

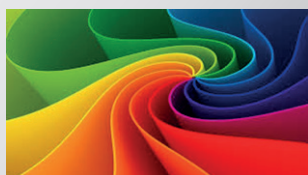

TFARGO

Std EU

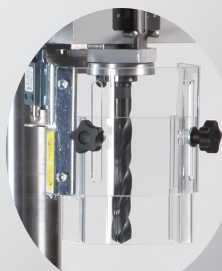

T25014 + T25052

MSC 
**Machinery
Scandinavia**

Machinery Scandinavia AB
570 83 Rosenfors, Sweden
Tel +46 495 49 700
Fax + 46 495 207 30
E-mail: sales@mscab.se
www.strandsmachinery.com